



CONTENT / NECESSITIES

2

A repair / connection plug, 11x



B adjustable solar-collector, +24m/4m²
(basic size 0.66x6m)



C connection tube, 4x



unlimited connection sizes & possibilities, examples:

- 1 set,
- 2 connection tubes + 2 collector lengths of max 12m, or any smaller size.
- 4 connection tubes + 4 collector lengths of max 6m, or any smaller size.

1 basic set + **2 additional sets**,
expand with extra sets and assemble to any size



1 basic set + **2 connection tubes**



1 basic set + **1 additional set**, using the connection plugs



INSTALLATION GUIDE

4

- 1** measure and cut collectors to desired installation size

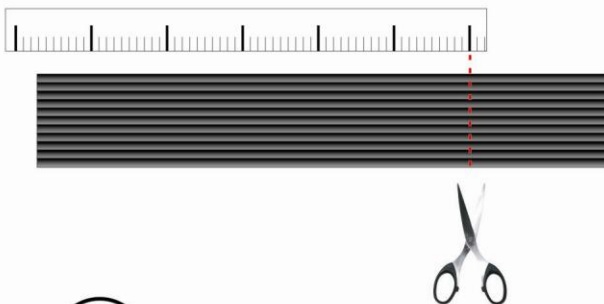

- 2** prepare collectors for installation

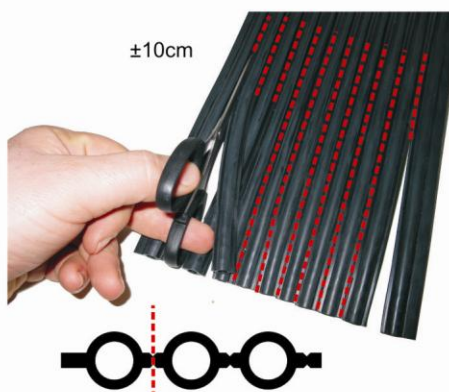

- 3** connect collectors in desired dimensions

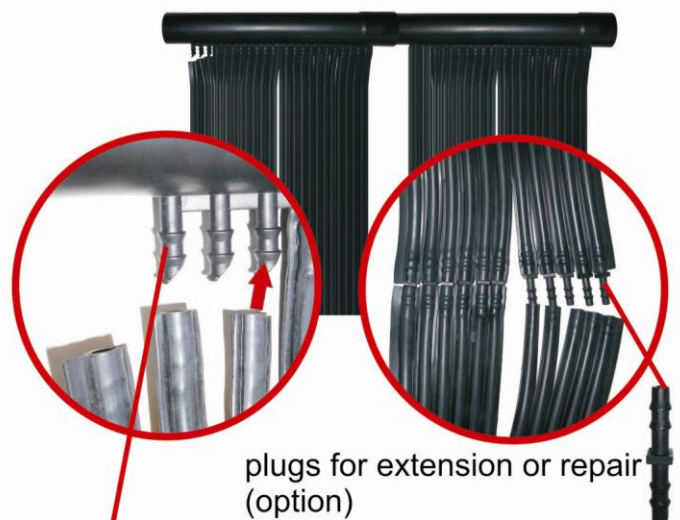

-  make plugs wet with water for easy connection to the collector-ends or use terpentine for fast connection

4 close system at tube ends and connect to swimming pool installation

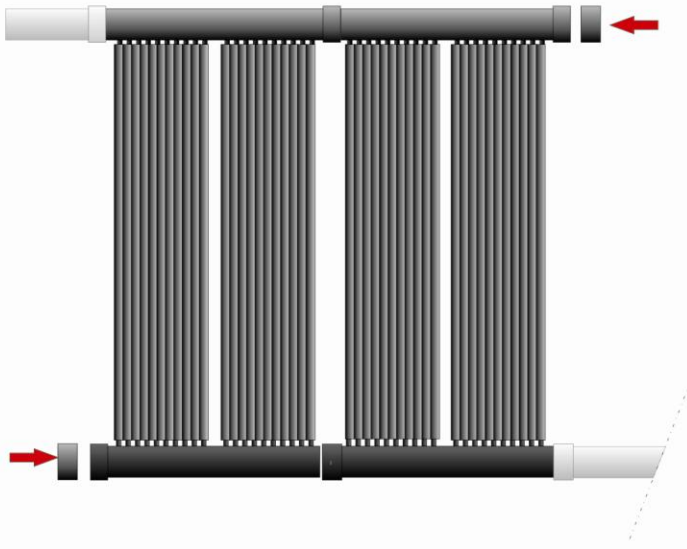

5 for permanent installation, fix system to underlying surface

a) use heavy tiles on shallow surfaces or when screws can not be used.

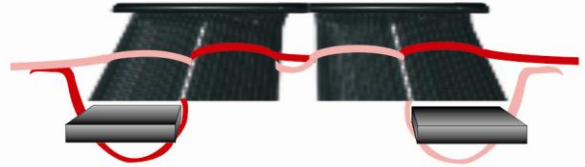

b) fix with screws to bottom surface, or lift roof tiles and fix screws to wood construction.

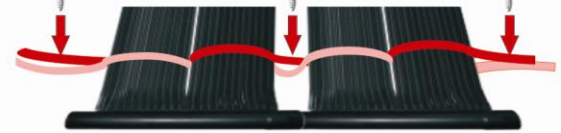

TYPICAL INSTALLATION SCHEME

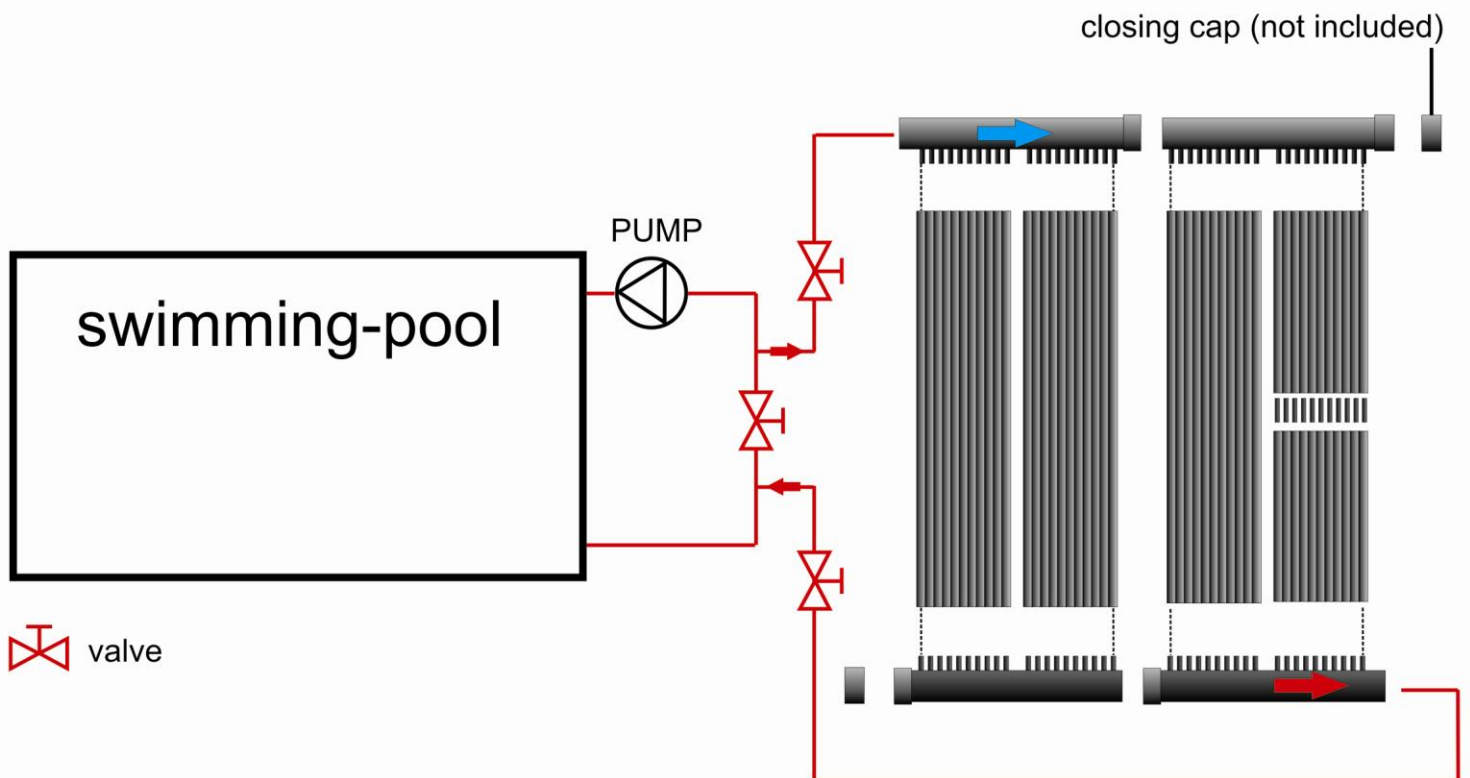

1. easy to fold around obstacles
2. work around any obstacle and connect to additional package to increase to any size
3. easy to bend to make corners



WARNINGS

Solar4pool can not be responsible for any damage caused due to installation of the system.

Fix solar4pool system to underlying surface with care.

Only for swimming-pool water warming.

Beware of sharp edges near collectors.

Release water from system in winter to avoid damage due to freezing.

www.solar4pool.com

CAN BE USED ON ALL SURFACES

